

ZGF-120kV/2mA

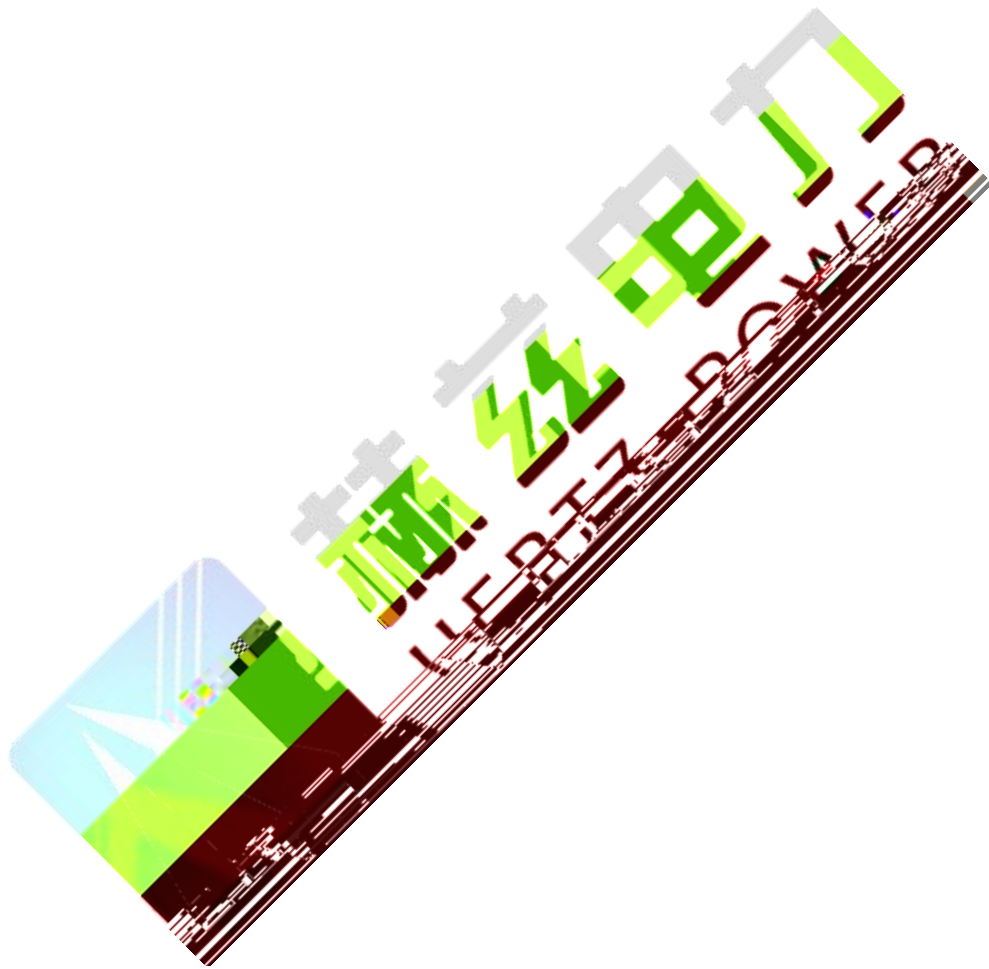



赫兹电力
HERTZ POWER

产品宗旨：技术领先，质量可靠，轻便易用

服务宗旨：快速响应，**达到满意，超过期望**

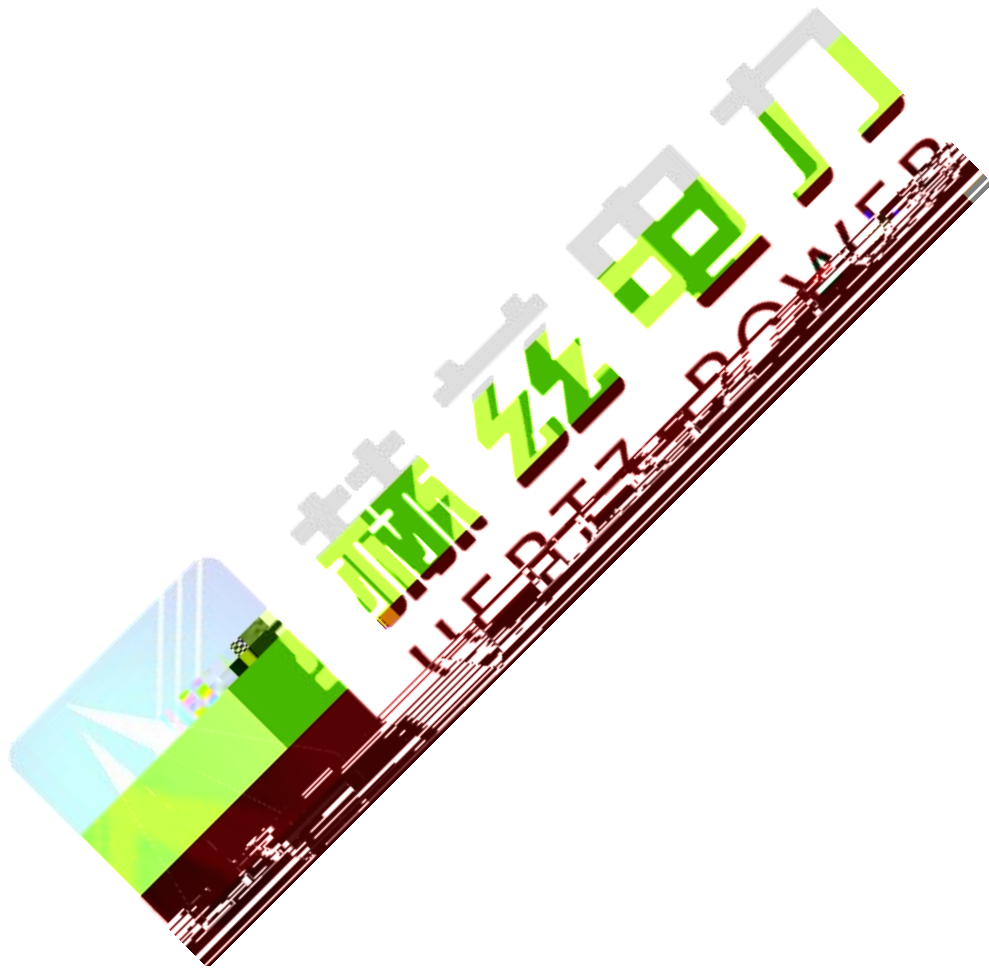



1.1

1.2

1.3

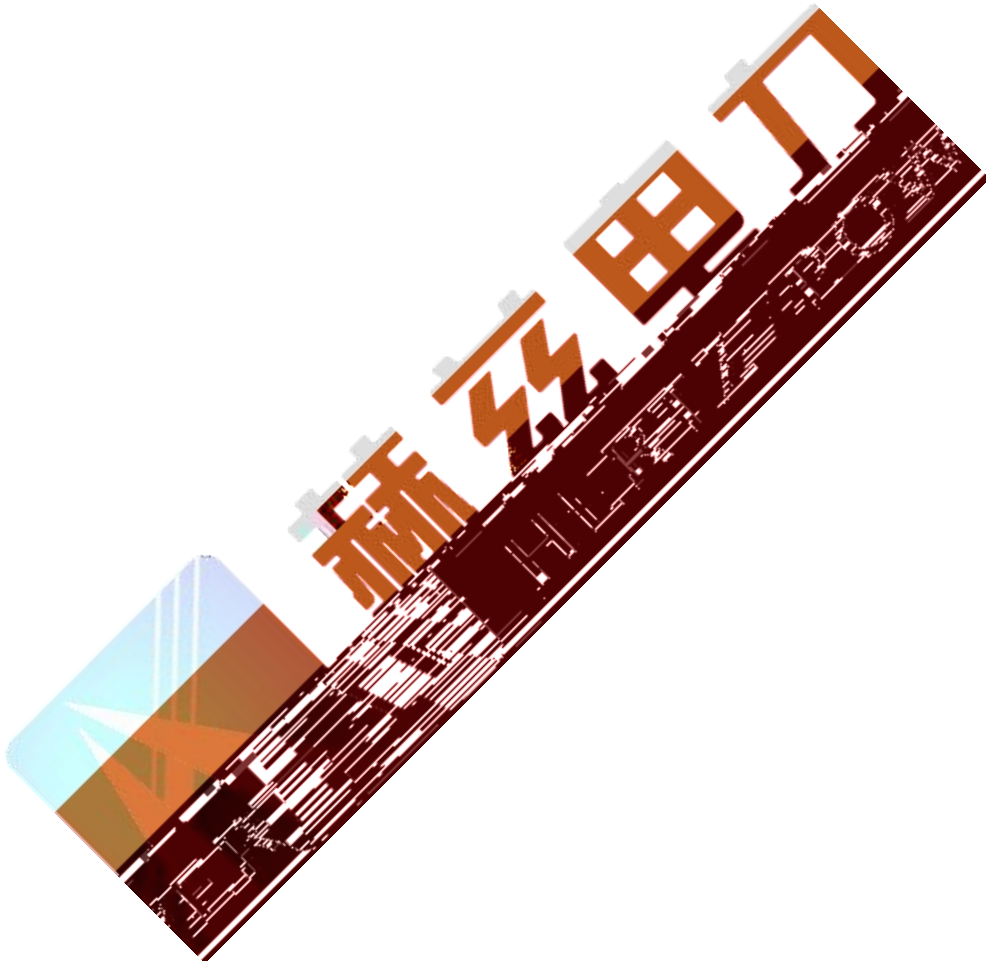



赫兹电力
HERTZ POWER

产品宗旨：技术领先，质量可靠，轻便易用

服务宗旨：快速响应，**达到满意，超过期望**

1. 4

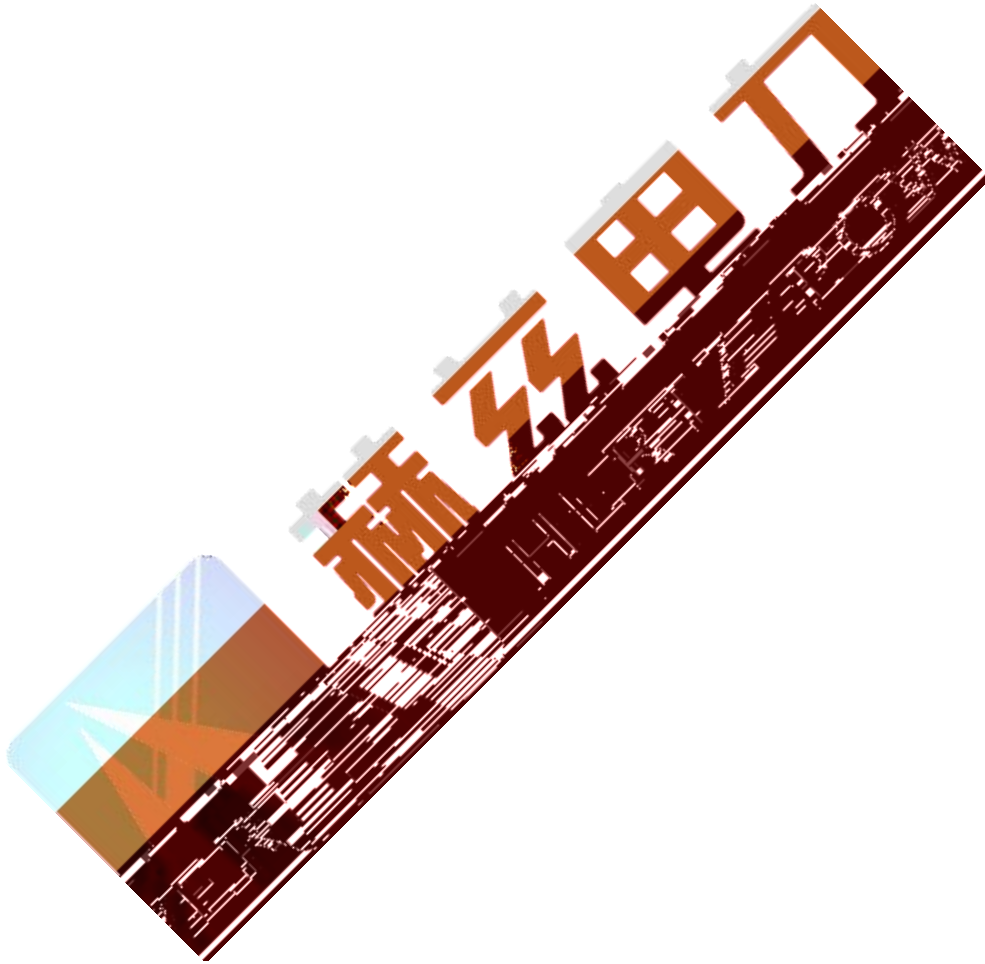



产品宗旨：技术领先，质量可靠，轻便易用
 服务宗旨：快速响应，**达到满意，超过期望**



-() \$ ÖÜ\$: Si 9H±5'5 Ö

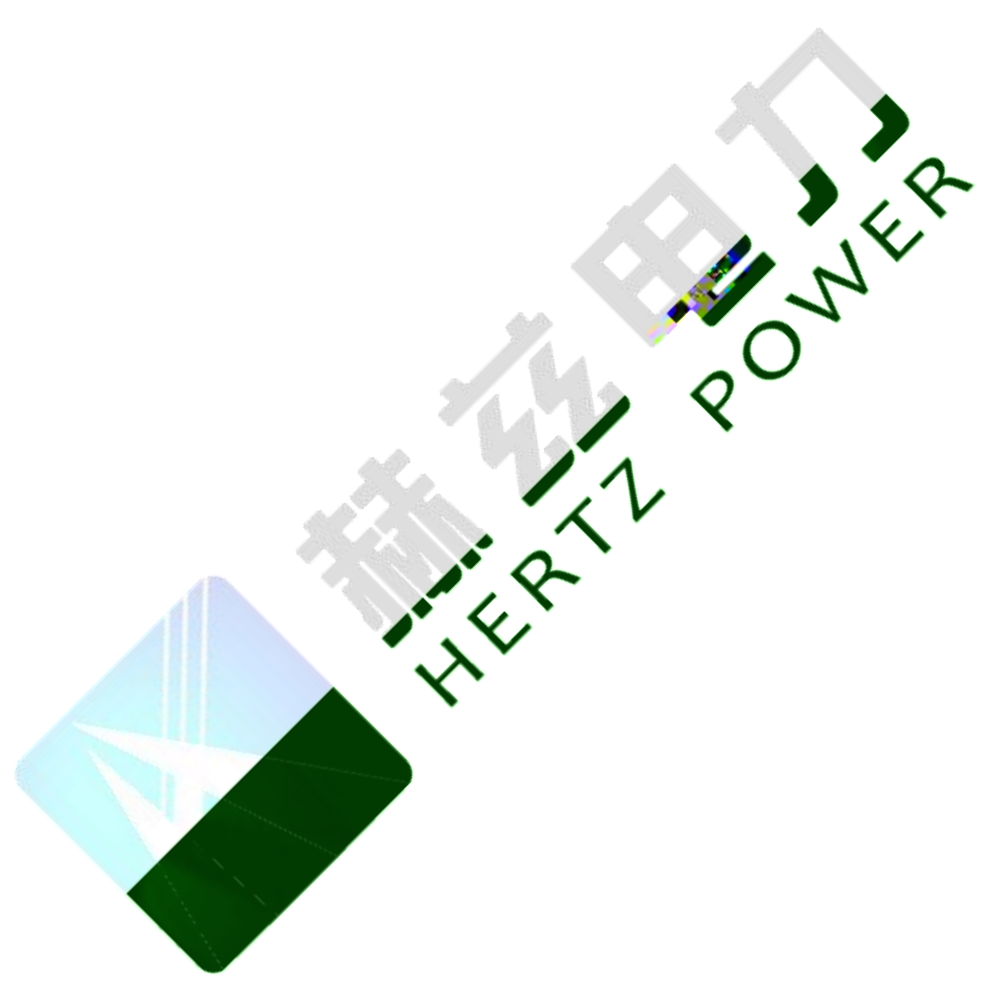

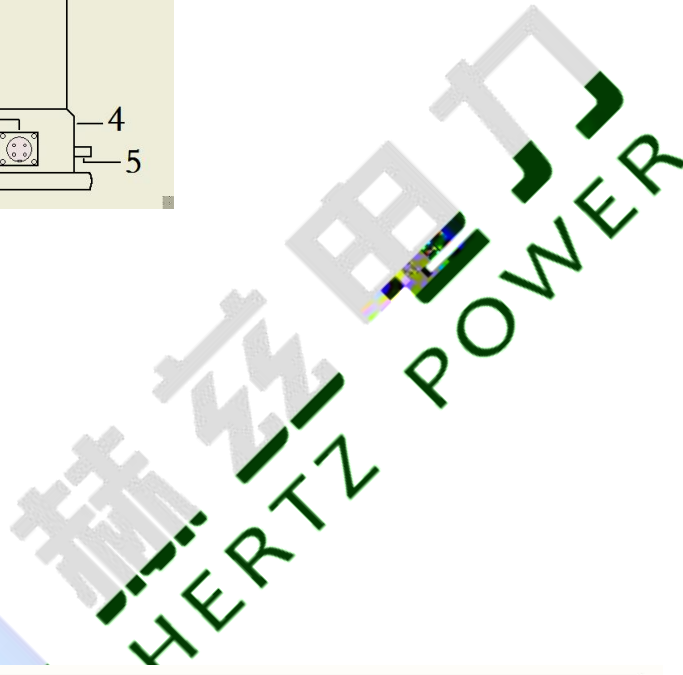
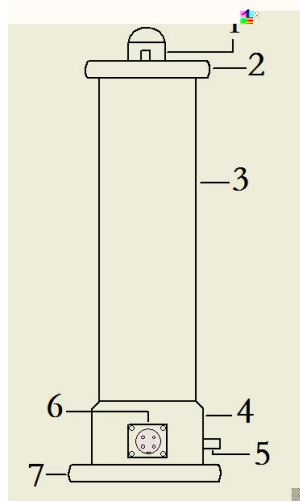

1.7



2.1

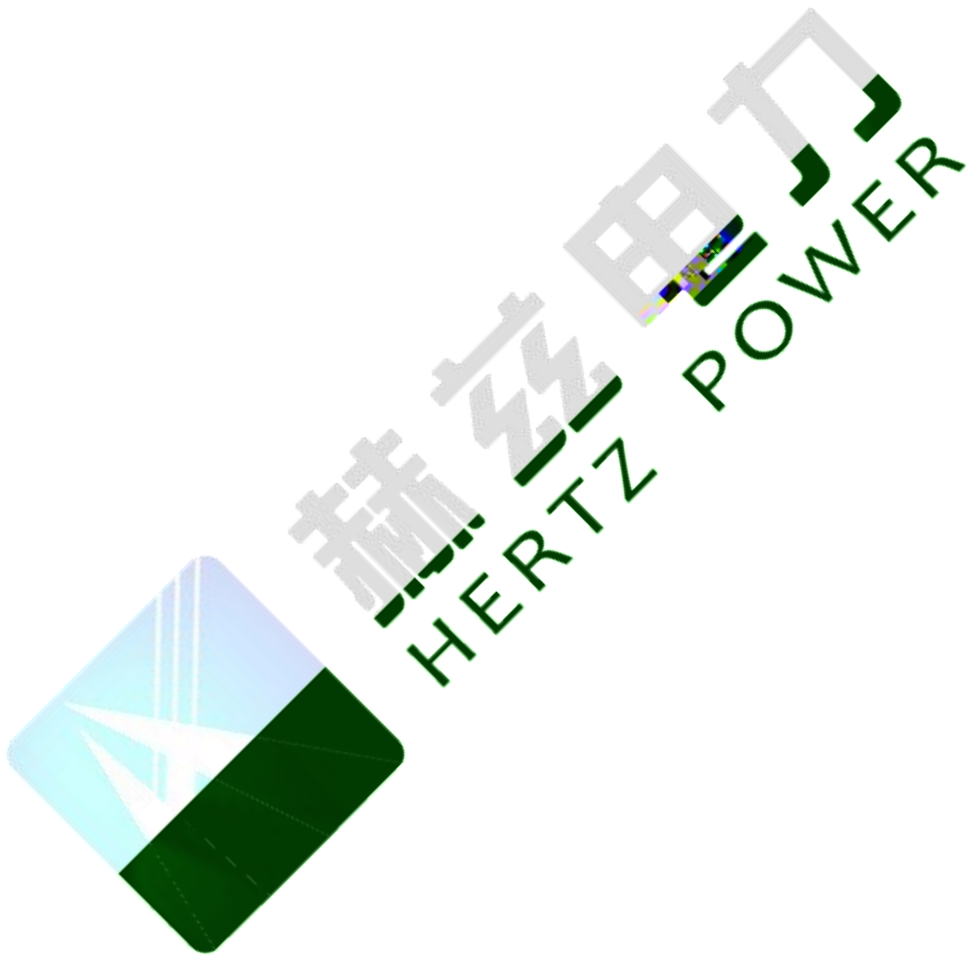



赫兹电力
HERTZ POWER

产品宗旨：技术领先，质量可靠，轻便易用
服务宗旨：快速响应，**达到满意，超过期望**

3.1

3.2

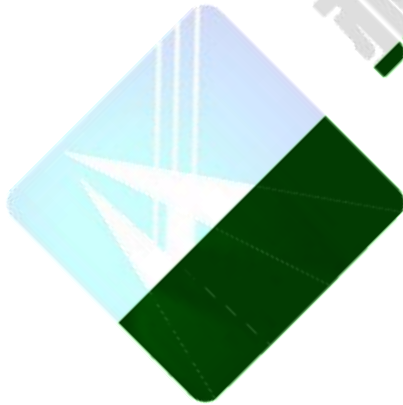

赫兹电力
HERTZ POWER

3.3



赫兹电力
HERTZ POWER

产品宗旨：技术领先，质量可靠，轻便易用

服务宗旨：快速响应，**达到满意，超过期望**

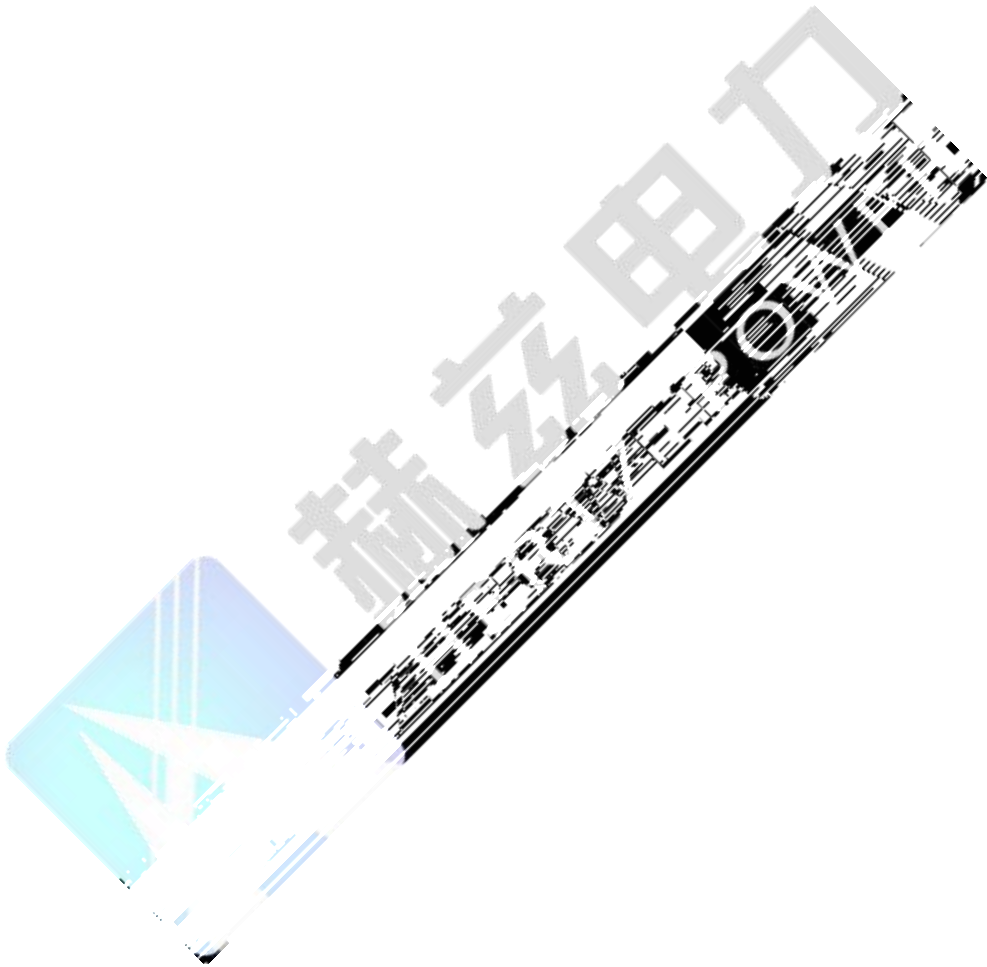



3.5

$I \quad I \quad I_o$

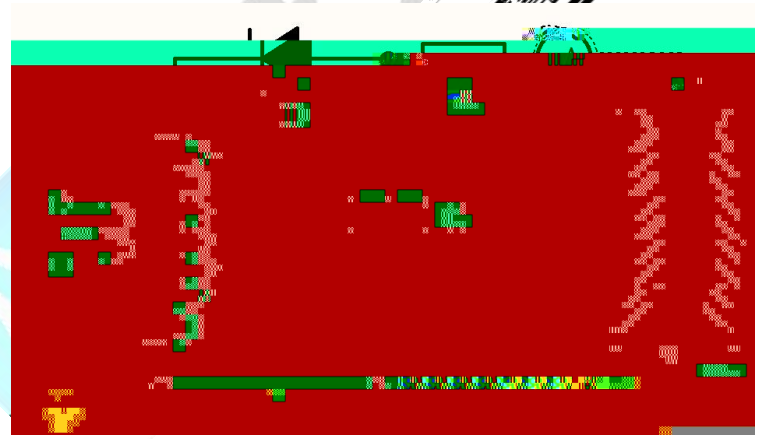

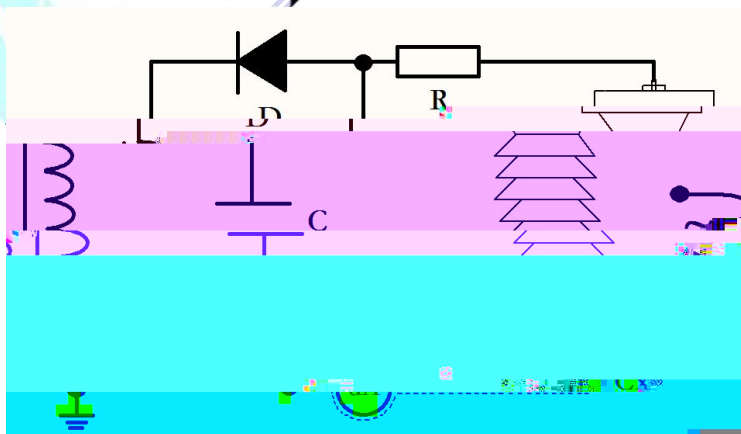
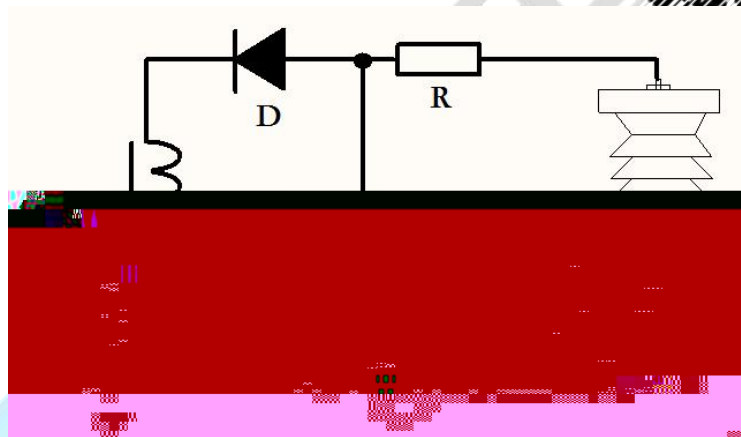
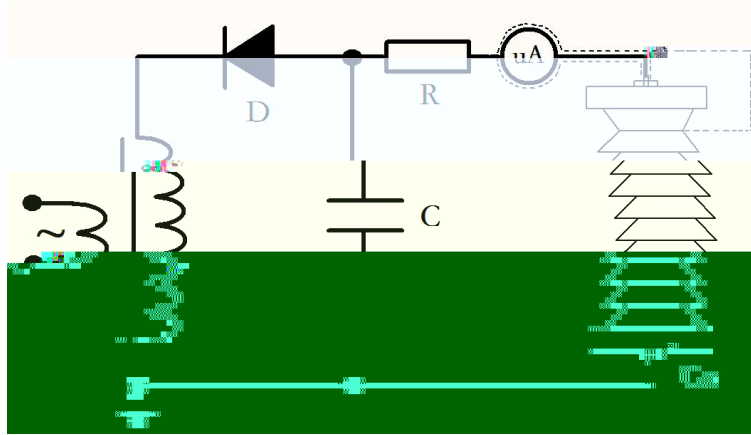



赫兹电力
HERTZ POWER

产品宗旨：技术领先，质量可靠，轻便易用

服务宗旨：快速响应，**达到满意，超过期望**

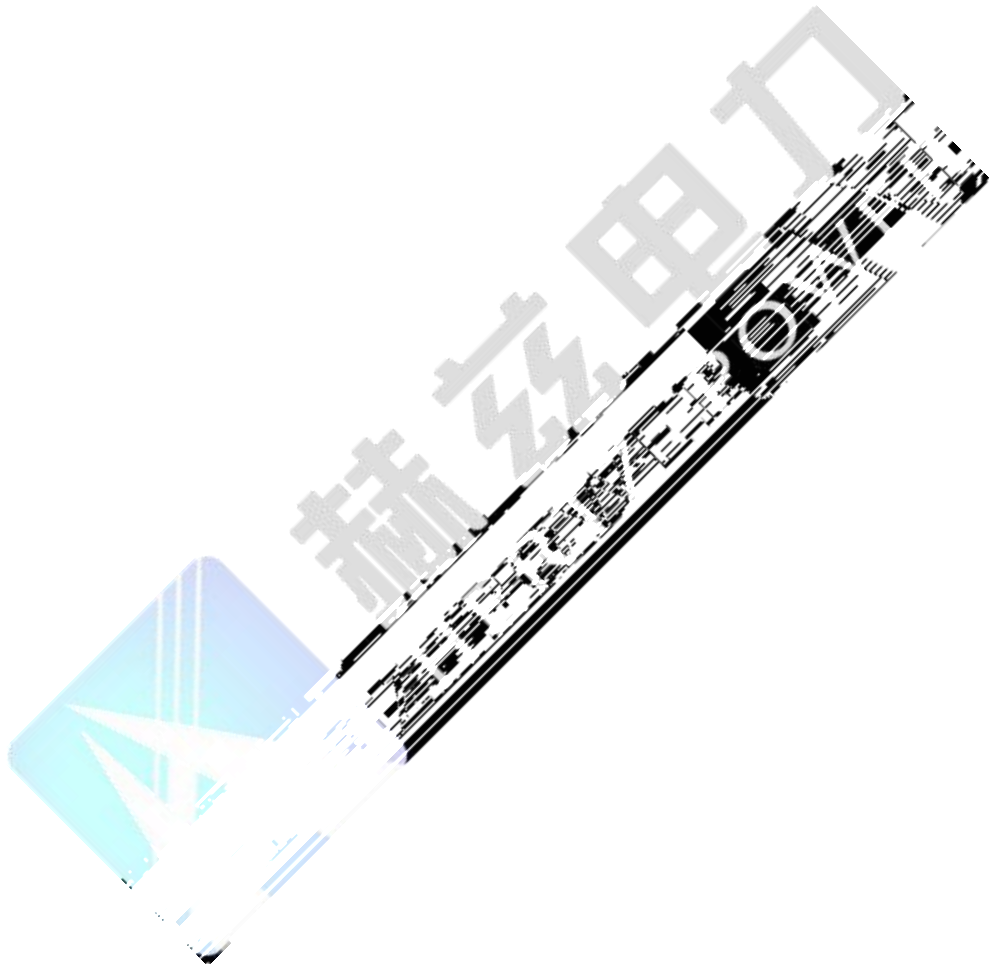



赫兹电力
HERTZ POWER

产品宗旨：技术领先，质量可靠，轻便易用

服务宗旨：快速响应，**达到满意，超过期望**

